

Centralized Power Supply

SB-60W-12-4



Feature:

- 60W 4chs. Output Power Supply Box
- Output voltage & current: DC12V 5A
- Input voltage range: 85~264VAC
- Built in EMI filter with tiny ripple
- 100% full load burn-in test
- Air Cooling
- Built-in constant current limiting circuit (C.C.+C.V.mode);
- Protection: Short circuit/ Overload/ Over voltage/ Over temperature

CE FC

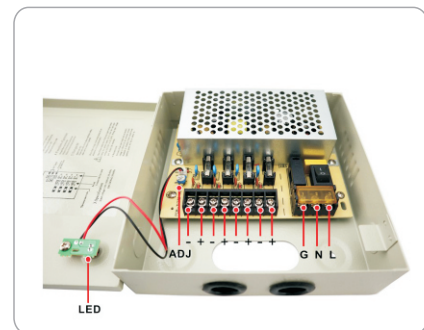

Specification:

Model	SB-60W-12-4	
Output	DC output Voltage	12V±1%
	Output Current Range	0-5A
	Wave and Noise	120mVp-p
	DC output Power	60W
	Efficiency	85%
	DC Voltage Adjustable Scope	(at full load) ≤0.5%
Input	Voltage Range	180~240VAC 47-63Hz
	Input Current	0.56A/115A, 0.28A/230V
	Leakage Current	<1mA/ 240VAC
	Inrush Current	Cold start 20A/120VAC, 40A/230VAC
Protection	Over-load	105%~135%, Protection type: Constant current limiting, recovers automatically after fault condition is removed
	Over-voltage	105%---150% Rated Voltage, Protection type: Shut off
	High-temperature	RTH3>=65°C FAN ON<=55°C FAN OFF>=80°C Cut off output(5~15V)
Environment	Working temperature & humidity	-10°C~+50°C, 20~90%RH
	Store temperature & humidity	-20°C~+85°C, 10~95%RH
	Temperature coefficient	±0.03%/°C(0~50°C)
	Vibration	10~500Hz,2G 10min./1cycle,Period for 60min,EACH AXES
Safety	Withstand voltage	I/P-O/P: 1.5KVAC, I/P-FG: 1.5KVAC, O/P-FG: 0.5KVAC
	Isolation resistance	I/P-O/P,I/P-FG,O/P-FG: 100M Ohms/500VDC
Standard	CE EMC Standard	EN55015:2013+A1:2015, EN61547:2009, EN61000-3-2:2014, EN61000-3-33:2013
	CE LVD Standard	EN61347-2-13:2014+A1:2017, EB61347-1:2015
	ROHS Standard	IEC 62321: 2013, EPA3050B:1996, EN1122:2001, EPA3052:1996, EPA3060A, etc.
Other	Dimension	164*165*47mm (L*W*H)
	Weight	0.7kg
Notes	<ol style="list-style-type: none"> 1. All parameters NOT specially mentioned are measured at 230VAC input, rated load and 25°C of ambient temperature. 2. Ripple & noise are measured at 20MHz of bandwidth by using a 12" twisted pair-wire terminated with a 0.1uf & 47uf parallel capacitor. 3. Tolerance : includes set up tolerance, line regulation and load regulation. 4. I/P-O/P: Input and output interval, I/P-FG: Input and enclosure, O/P-FG: Output and enclosure 	

Centralized Power Supply

SB-60W-12-9

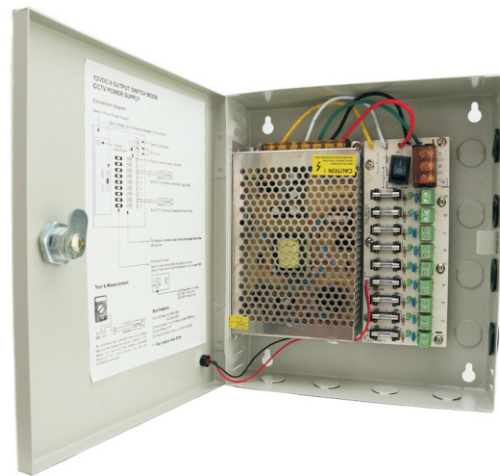

Feature:

- 60W 9chs. Output Power Supply Box
- Output voltage & current: DC12V 5A
- Input voltage range: 85~264VAC
- Built in EMI filter with tiny ripple
- 100% full load burn-in test
- Air Cooling
- Built-in constant current limiting circuit (C.C.+C.V.mode);
- Protection: Short circuit/ Overload/ Over voltage/ Over temperature

CE FC

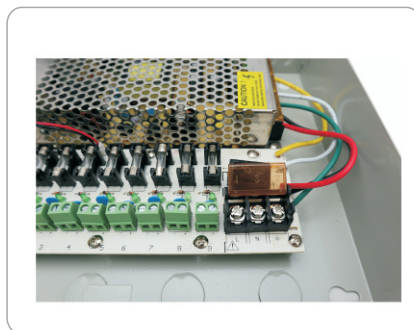
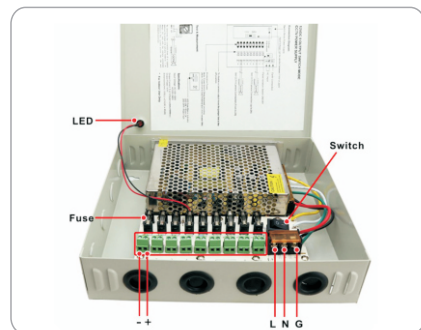

Specification:

Model	SB-60W-12-9	
Output	DC output Voltage	12V±1%
	Output Current Range	0-5A
	Wave and Noise	120mVp-p
	DC output Power	60W
	Efficiency	85%
	DC Voltage Adjustable Scope	(at full load) ≤0.5%
Input	Voltage Range	180~240VAC 47-63Hz
	Input Current	0.56A/115A, 0.28A/230V
	Leakage Current	<1mA/ 240VAC
	Inrush Current	Cold start 20A/120VAC, 40A/230VAC
Protection	Over-load	105%~135%, Protection type: Constant current limiting, recovers automatically after fault condition is removed
	Over-voltage	105%---150% Rated Voltage, Protection type: Shut off
	High-temperature	RTH3>=65°C FAN ON<=55°C FAN OFF>=80°C Cut off output(5~15V)
Environment	Working temperature & humidity	-10°C~+50°C, 20~90%RH
	Store temperature & humidity	-20°C~+85°C, 10~95%RH
	Temperature coefficient	±0.03%/°C(0~50°C)
	Vibration	10~500Hz,2G 10min./1cycle,Period for 60min,EACH AXES
Safety	Withstand voltage	I/P-O/P: 1.5KVAC, I/P-FG: 1.5KVAC, O/P-FG: 0.5KVAC
	Isolation resistance	I/P-O/P,I/P-FG,O/P-FG: 100M Ohms/500VDC
Standard	CE EMC Standard	EN55015:2013+A1:2015, EN61547:2009, EN61000-3-2:2014, EN61000-3-33:2013
	CE LVD Standard	EN61347-2-13:2014+A1:2017, EB61347-1:2015
	ROHS Standard	IEC 62321: 2013, EPA3050B:1996, EN1122:2001, EPA3052:1996, EPA3060A, etc.
Other	Dimension	204*235*55mm (L*W*H)
	Weight	1.3kg
Notes	<ol style="list-style-type: none"> 1. All parameters NOT specially mentioned are measured at 230VAC input, rated load and 25°C of ambient temperature. 2. Ripple & noise are measured at 20MHz of bandwidth by using a 12" twisted pair-wire terminated with a 0.1uf & 47uf parallel capacitor. 3. Tolerance : includes set up tolerance, line regulation and load regulation. 4. I/P-O/P: Input and output interval, I/P-FG: Input and enclosure, O/P-FG: Output and enclosure 	

Centralized Power Supply

SB-120W-12-8

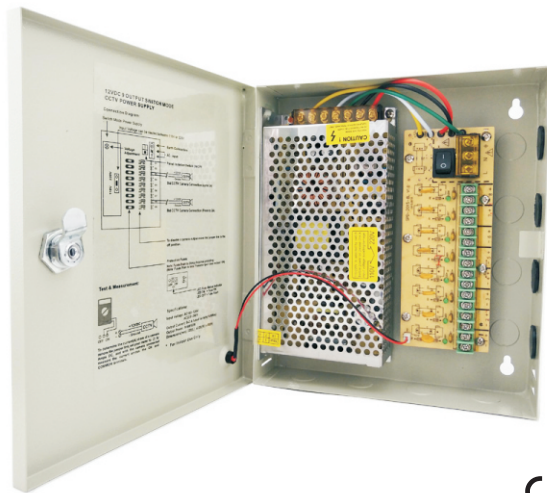

Feature:

- 120W 8chs. Output Power Supply Box
- Output voltage & current: DC12V 10A
- Input voltage range: 85~264VAC
- Built in EMI filter with tiny ripple
- 100% full load burn-in test
- Air Cooling
- Built-in constant current limiting circuit (C.C.+C.V.mode);
- Protection: Short circuit/ Overload/ Over voltage/ Over temperature

CE FC

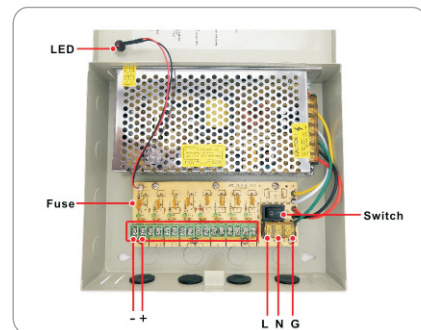

Specification:

Model	SB-120W-12-8	
Output	DC output Voltage	12V±1%
	Output Current Range	0-10A
	Wave and Noise	120mVp-p
	DC output Power	120W
	Efficiency	85%
	DC Voltage Adjustable Scope	(at full load) ≤0.5%
Input	Voltage Range	180~240VAC 47-63Hz
	Input Current	1.1A/115A, 0.53A/230V
	Leakage Current	<1mA/ 240VAC
	Inrush Current	Cold start 20A/120VAC, 40A/230VAC
Protection	Over-load	105%~135%, Protection type: Constant current limiting, recovers automatically after fault condition is removed
	Over-voltage	105%---150% Rated Voltage, Protection type: Shut off
	High-temperature	RTH3>=65°C FAN ON<=55°C FAN OFF>=80°C Cut off output(5~15V)
Environment	Working temperature & humidity	-10°C~+50°C, 20~90%RH
	Store temperature & humidity	-20°C~+85°C, 10~95%RH
	Temperature coefficient	±0.03%°C(0~50°C)
	Vibration	10~500Hz,2G 10min./1cycle,Period for 60min,EACH AXES
Safety	Withstand voltage	I/P-O/P: 1.5KVAC, I/P-FG: 1.5KVAC, O/P-FG: 0.5KVAC
	Isolation resistance	I/P-O/P,I/P-FG,O/P-FG: 100M Ohms/500VDC
Standard	CE EMC Standard	EN55015:2013+A1:2015, EN61547:2009, EN61000-3-2:2014, EN61000-3-33:2013
	CE LVD Standard	EN61347-2-13:2014+A1:2017, EB61347-1:2015
	ROHS Standard	IEC 62321: 2013, EPA3050B:1996, EN1122:2001, EPA3052:1996, EPA3060A, etc.
Other	Dimension	204*235*55mm (L*W*H)
	Weight	1.45kg
Notes	<p>1. All parameters NOT specially mentioned are measured at 230VAC input, rated load and 25°C of ambient temperature.</p> <p>2. Ripple & noise are measured at 20MHz of bandwidth by using a 12" twisted pair-wire terminated with a 0.1uf & 47uf parallel capacitor.</p> <p>3. Tolerance : includes set up tolerance, line regulation and load regulation.</p> <p>4. I/P-O/P: Input and output interval, I/P-FG: Input and enclosure, O/P-FG: Output and enclosure</p>	

Centralized Power Supply

SB-120W-12-9

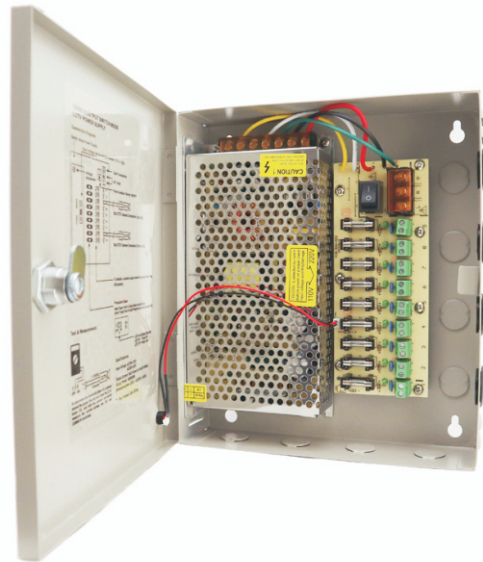

Feature:

- 120W 9chs. Output Power Supply Box
- Output voltage & current: DC12V 10A
- Input voltage range: 85~264VAC
- Built in EMI filter with tiny ripple
- 100% full load burn-in test
- Air Cooling
- Built-in constant current limiting circuit (C.C.+C.V.mode);
- Protection: Short circuit/ Overload/ Over voltage/ Over temperature

CE FC

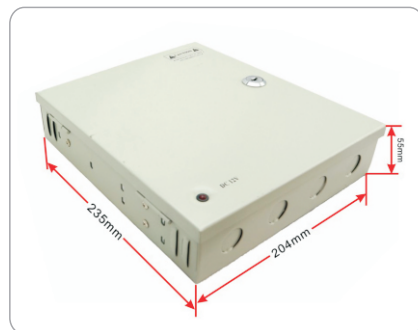
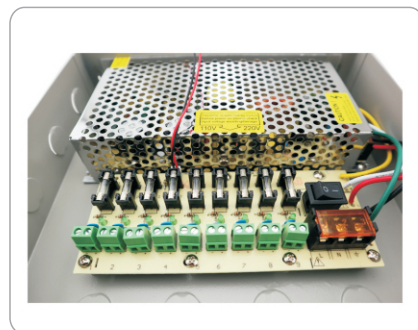
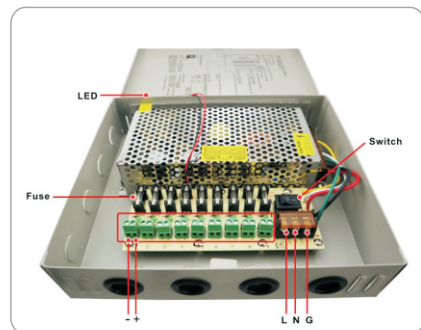

Specification:

Model	SB-120W-12-9	
Output	DC output Voltage	12V±1%
	Output Current Range	0-10A
	Wave and Noise	120mVp-p
	DC output Power	120W
	Efficiency	85%
	DC Voltage Adjustable Scope	(at full load)≤0.5%
Input	Voltage Range	180~240VAC 47-63Hz
	Input Current	1.1A/115A, 0.53A/230V
	Leakage Current	<1mA/ 240VAC
	Inrush Current	Cold start 20A/120VAC, 40A/230VAC
Protection	Over-load	105%~135%, Protection type: Constant current limiting, recovers automatically after fault condition is removed
	Over-voltage	105%---150% Rated Voltage, Protection type: Shut off
	High-temperature	RTH3>=65°C FAN ON<=55°C FAN OFF>=80°C Cut off output(5~15V)
Environment	Working temperature & humidity	-10°C~+50°C, 20~90%RH
	Store temperature & humidity	-20°C~+85°C, 10~95%RH
	Temperature coefficient	±0.03%/°C(0~50°C)
	Vibration	10~500Hz,2G 10min./1cycle,Period for 60min,EACH AXES
Safety	Withstand voltage	I/P-O/P: 1.5KVAC, I/P-FG: 1.5KVAC, O/P-FG: 0.5KVAC
	Isolation resistance	I/P-O/P,I/P-FG,O/P-FG: 100M Ohms/500VDC
Standard	CE EMC Standard	EN55015:2013+A1:2015, EN61547:2009, EN61000-3-2:2014, EN61000-3-33:2013
	CE LVD Standard	EN61347-2-13:2014+A1:2017, EB61347-1:2015
	ROHS Standard	IEC 62321: 2013, EPA3050B:1996, EN1122:2001, EPA3052:1996, EPA3060A, etc.
Other	Dimension	204*235*55mm (L*W*H)
	Weight	1.45kg
Notes	<ol style="list-style-type: none"> 1. All parameters NOT specially mentioned are measured at 230VAC input, rated load and 25°C of ambient temperature. 2. Ripple & noise are measured at 20MHz of bandwidth by using a 12" twisted pair-wire terminated with a 0.1uf & 47uf parallel capacitor. 3. Tolerance : includes set up tolerance, line regulation and load regulation. 4. I/P-O/P: Input and output interval, I/P-FG: Input and enclosure, O/P-FG: Output and enclosure 	

Centralized Power Supply

SB-180W-12-9

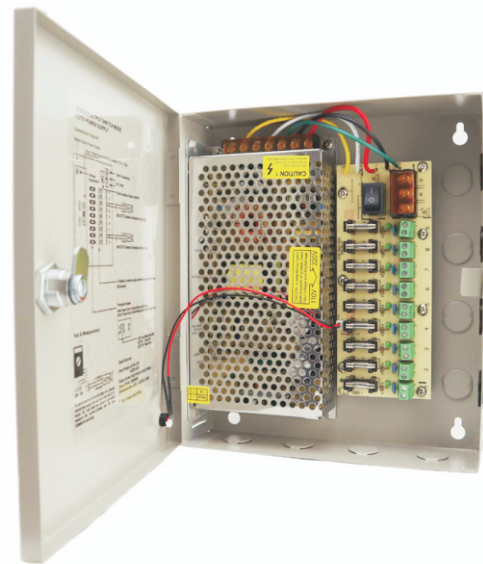

Feature:

- 180W 9chs. Output Power Supply Box
- Output voltage & current: DC12V 15A
- Input voltage range: 85~264VAC
- Built in EMI filter with tiny ripple
- 100% full load burn-in test
- Air Cooling
- Built-in constant current limiting circuit (C.C.+C.V.mode);
- Protection: Short circuit/ Overload/ Over voltage/ Over temperature

CE FC

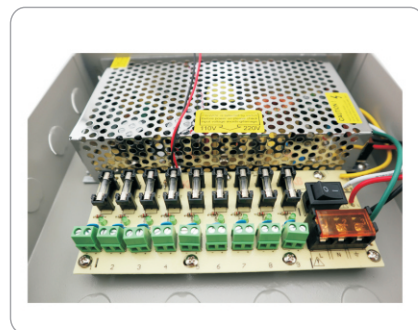
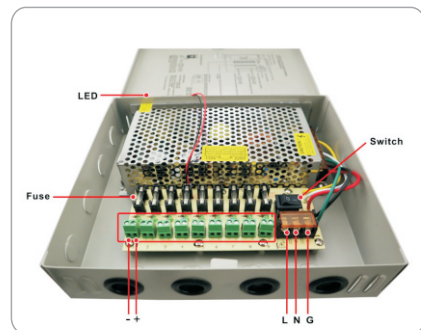

Specification:

Model	SB-180W-12-9	
Output	DC output Voltage	12V±1%
	Output Current Range	0-15A
	Wave and Noise	120mVp-p
	DC output Power	180W
	Efficiency	85%
	DC Voltage Adjustable Scope	(at full load) ≤0.5%
Input	Voltage Range	180~240VAC 47-63Hz
	Input Current	1.6A/115A, 0.8A/230V
	Leakage Current	<1mA/ 240VAC
	Inrush Current	Cold start 20A/120VAC, 40A/230VAC
Protection	Over-load	105%~135%, Protection type: Constant current limiting, recovers automatically after fault condition is removed
	Over-voltage	105%---150% Rated Voltage, Protection type: Shut off
	High-temperature	RTH3>=65°C FAN ON<=55°C FAN OFF>=80°C Cut off output(5~15V)
Environment	Working temperature & humidity	-10°C~+50°C, 20~90%RH
	Store temperature & humidity	-20°C~+85°C, 10~95%RH
	Temperature coefficient	±0.03%/°C(0~50°C)
	Vibration	10~500Hz,2G 10min./1cycle,Period for 60min,EACH AXES
Safety	Withstand voltage	I/P-O/P: 1.5KVAC, I/P-FG: 1.5KVAC, O/P-FG: 0.5KVAC
	Isolation resistance	I/P-O/P,I/P-FG,O/P-FG: 100M Ohms/500VDC
Standard	CE EMC Standard	EN55015:2013+A1:2015, EN61547:2009, EN61000-3-2:2014, EN61000-3-33:2013
	CE LVD Standard	EN61347-2-13:2014+A1:2017, EB61347-1:2015
	ROHS Standard	IEC 62321: 2013, EPA3050B:1996, EN1122:2001, EPA3052:1996, EPA3060A, etc.
Other	Dimension	204*235*55mm (L*W*H)
	Weight	1.55kg
Notes	<ol style="list-style-type: none"> 1. All parameters NOT specially mentioned are measured at 230VAC input, rated load and 25°C of ambient temperature. 2. Ripple & noise are measured at 20MHz of bandwidth by using a 12" twisted pair-wire terminated with a 0.1uf & 47uf parallel capacitor. 3. Tolerance : includes set up tolerance, line regulation and load regulation. 4. I/P-O/P: Input and output interval, I/P-FG: Input and enclosure, O/P-FG: Output and enclosure 	

Centralized Power Supply

SB-120W-12-18



Feature:

- 120W 18chs. Output Power Supply Box
- Output voltage & current: DC12V 10A
- Input voltage range: 85~264VAC
- Built in EMI filter with tiny ripple
- 100% full load burn-in test
- Air Cooling
- Built-in constant current limiting circuit (C.C.+C.V.mode);
- Protection: Short circuit/ Overload/ Over voltage/ Over temperature

CE FC

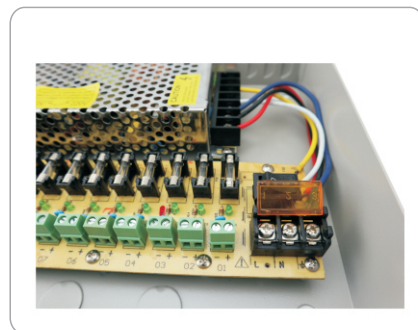
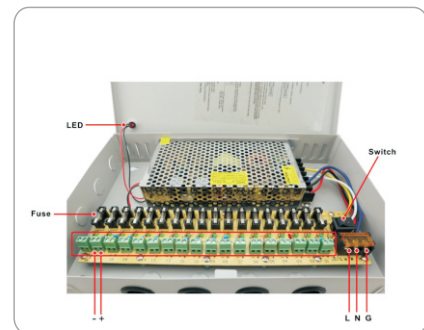

Specification:

Model	SB-120W-12-18	
Output	DC output Voltage	12V±1%
	Output Current Range	0-10A
	Wave and Noise	120mVp-p
	DC output Power	120W
	Efficiency	85%
	DC Voltage Adjustable Scope	(at full load) ≤0.5%
Input	Voltage Range	180~240VAC 47-63Hz
	Input Current	1.1A/115A, 0.53A/230V
	Leakage Current	<1mA/ 240VAC
	Inrush Current	Cold start 20A/120VAC, 40A/230VAC
Protection	Over-load	105%~135%, Protection type: Constant current limiting, recovers automatically after fault condition is removed
	Over-voltage	105%---150% Rated Voltage, Protection type: Shut off
	High-temperature	RTH3>=65°C FAN ON<=55°C FAN OFF>=80°C Cut off output(5~15V)
Environment	Working temperature & humidity	-10°C~+50°C, 20~90%RH
	Store temperature & humidity	-20°C~+85°C, 10~95%RH
	Temperature coefficient	±0.03%/°C(0~50°C)
	Vibration	10~500Hz,2G 10min./1cycle,Period for 60min,EACH AXES
Safety	Withstand voltage	I/P-O/P: 1.5KVAC, I/P-FG: 1.5KVAC, O/P-FG: 0.5KVAC
	Isolation resistance	I/P-O/P,I/P-FG,O/P-FG: 100M Ohms/500VDC
Standard	CE EMC Standard	EN55015:2013+A1:2015, EN61547:2009, EN61000-3-2:2014, EN61000-3-33:2013
	CE LVD Standard	EN61347-2-13:2014+A1:2017, EB61347-1:2015
	ROHS Standard	IEC 62321: 2013, EPA3050B:1996, EN1122:2001, EPA3052:1996, EPA3060A, etc.
Other	Dimension	206*315*58mm (L*W*H)
	Weight	1.65kg
Notes	<ol style="list-style-type: none"> 1. All parameters NOT specially mentioned are measured at 230VAC input, rated load and 25°C of ambient temperature. 2. Ripple & noise are measured at 20MHz of bandwidth by using a 12" twisted pair-wire terminated with a 0.1uf & 47uf parallel capacitor. 3. Tolerance : includes set up tolerance, line regulation and load regulation. 4. I/P-O/P: Input and output interval, I/P-FG: Input and enclosure, O/P-FG: Output and enclosure 	

Centralized Power Supply

SB-180W-12-18

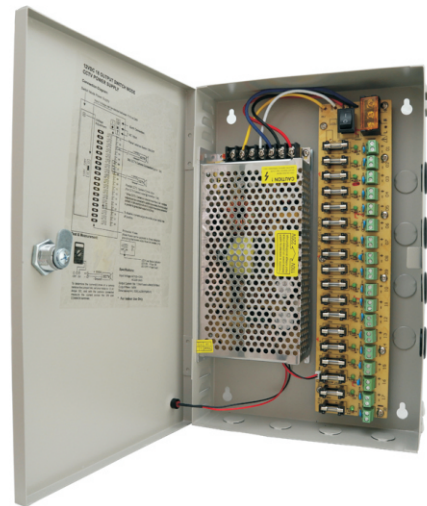

Feature:

- 180W 18chs. Output Power Supply Box
- Output voltage & current: DC12V 15A
- Input voltage range: 85~264VAC
- Built in EMI filter with tiny ripple
- 100% full load burn-in test
- Air Cooling
- Built-in constant current limiting circuit (C.C.+C.V.mode);
- Protection: Short circuit/ Overload/ Over voltage/ Over temperature

CE FC

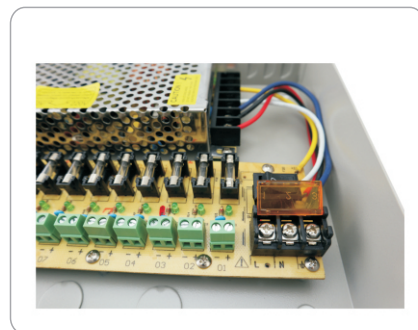
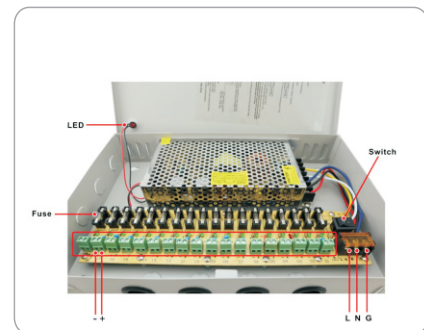

Specification:

Model	SB-180W-12-18	
Output	DC output Voltage	12V±1%
	Output Current Range	0-15A
	Wave and Noise	120mVp-p
	DC output Power	180W
	Efficiency	85%
	DC Voltage Adjustable Scope	(at full load)≤0.5%
Input	Voltage Range	180~240VAC 47-63Hz
	Input Current	1.6A/115A, 0.8A/230V
	Leakage Current	<1mA/ 240VAC
	Inrush Current	Cold start 20A/120VAC, 40A/230VAC
Protection	Over-load	105%~135%, Protection type: Constant current limiting, recovers automatically after fault condition is removed
	Over-voltage	105%---150% Rated Voltage, Protection type: Shut off
	High-temperature	RTH3>=65°C FAN ON<=55°C FAN OFF>=80°C Cut off output(5~15V)
Environment	Working temperature & humidity	-10°C~+50°C, 20~90%RH
	Store temperature & humidity	-20°C~+85°C, 10~95%RH
	Temperature coefficient	±0.03%/°C(0~50°C)
	Vibration	10~500Hz,2G 10min./1cycle,Period for 60min,EACH AXES
Safety	Withstand voltage	I/P-O/P: 1.5KVAC, I/P-FG: 1.5KVAC, O/P-FG: 0.5KVAC
	Isolation resistance	I/P-O/P,I/P-FG,O/P-FG: 100M Ohms/500VDC
Standard	CE EMC Standard	EN55015:2013+A1:2015, EN61547:2009, EN61000-3-2:2014, EN61000-3-33:2013
	CE LVD Standard	EN61347-2-13:2014+A1:2017, EB61347-1:2015
	ROHS Standard	IEC 62321: 2013, EPA3050B:1996, EN1122:2001, EPA3052:1996, EPA3060A, etc.
Other	Dimension	206*315*587mm (L*W*H)
	Weight	1.75kg
Notes	<ol style="list-style-type: none"> 1. All parameters NOT specially mentioned are measured at 230VAC input, rated load and 25°C of ambient temperature. 2. Ripple & noise are measured at 20MHz of bandwidth by using a 12" twisted pair-wire terminated with a 0.1uf & 47uf parallel capacitor. 3. Tolerance : includes set up tolerance, line regulation and load regulation. 4. I/P-O/P: Input and output interval, I/P-FG: Input and enclosure, O/P-FG: Output and enclosure 	

Centralized Power Supply

SB-240W-12-18

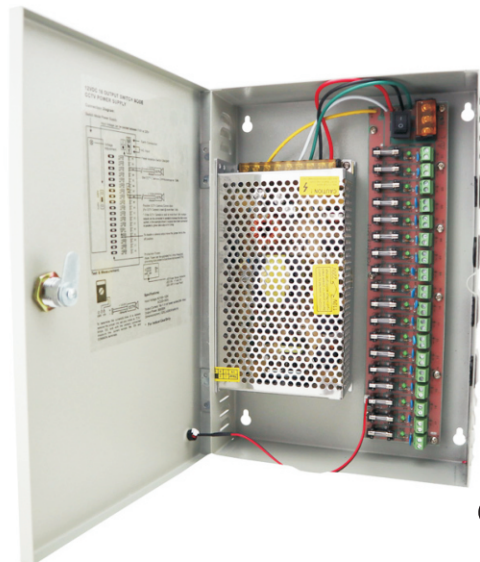

CE FC



Feature:

- 240W 18chs. Output Power Supply Box
- Output voltage & current: DC12V 20A
- Input voltage range: 85~264VAC
- Built in EMI filter with tiny ripple
- 100% full load burn-in test
- Air Cooling
- Built-in constant current limiting circuit (C.C.+C.V.mode);
- Protection: Short circuit/ Overload/ Over voltage/ Over temperature

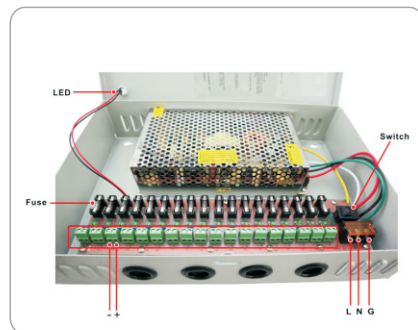

Specification:

Model	SB-240W-12-18	
Output	DC output Voltage	12V±1%
	Output Current Range	0-20A
	Wave and Noise	120mVp-p
	DC output Power	240W
	Efficiency	85%
	DC Voltage Adjustable Scope	(at full load)≤0.5%
Input	Voltage Range	180~240VAC 47-63Hz
	Input Current	2.2A/115A, 1.1A/230V
	Leakage Current	<1mA/ 240VAC
	Inrush Current	Cold start 20A/120VAC, 40A/230VAC
Protection	Over-load	105%~135%, Protection type: Constant current limiting, recovers automatically after fault condition is removed
	Over-voltage	105%---150% Rated Voltage, Protection type: Shut off
	High-temperature	RTH3>=65°C FAN ON<=55°C FAN OFF>=80°C Cut off output(5~15V)
Environment	Working temperature & humidity	-10°C~+50°C, 20~90%RH
	Store temperature & humidity	-20°C~+85°C, 10~95%RH
	Temperature coefficient	±0.03%/°C(0~50°C)
	Vibration	10~500Hz,2G 10min./1cycle,Period for 60min,EACH AXES
Safety	Withstand voltage	I/P-O/P: 1.5KVAC, I/P-FG: 1.5KVAC, O/P-FG: 0.5KVAC
	Isolation resistance	I/P-O/P,I/P-FG,O/P-FG: 100M Ohms/500VDC
Standard	CE EMC Standard	EN55015:2013+A1:2015, EN61547:2009, EN61000-3-2:2014, EN61000-3-33:2013
	CE LVD Standard	EN61347-2-13:2014+A1:2017, EB61347-1:2015
	ROHS Standard	IEC 62321: 2013, EPA3050B:1996, EN1122:2001, EPA3052:1996, EPA3060A, etc.
Other	Dimension	215*315*63mm (L*W*H)
	Weight	1.95kg
Notes	<ol style="list-style-type: none"> 1. All parameters NOT specially mentioned are measured at 230VAC input, rated load and 25°C of ambient temperature. 2. Ripple & noise are measured at 20MHz of bandwidth by using a 12" twisted pair-wire terminated with a 0.1uf & 47uf parallel capacitor. 3. Tolerance : includes set up tolerance, line regulation and load regulation. 4. I/P-O/P: Input and output interval, I/P-FG: Input and enclosure, O/P-FG: Output and enclosure 	

Centralized Power Supply

SB-360W-12-18



Feature:

- 360W 18chs. Output Power Supply Box
- Output voltage & current: DC12V 30A
- Input voltage range: 85~264VAC
- Built in EMI filter with tiny ripple
- 100% full load burn-in test
- Forced air Cooling by built-in DC fan
- Built-in constant current limiting circuit (C.C.+C.V.mode);
- Protection: Short circuit/ Overload/ Over voltage/ Over temperature

CE FC

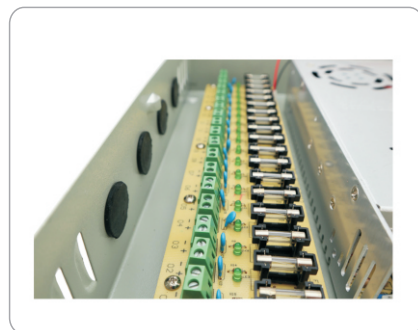
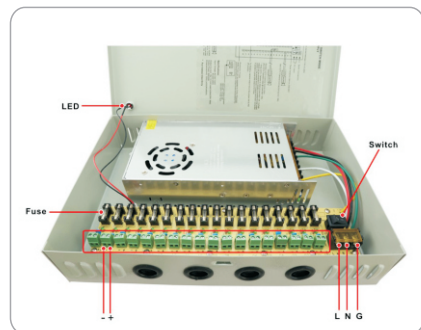

Specification:

Model	SB-360W-12-18	
Output	DC output Voltage	12V±1%
	Output Current Range	0-30A
	Wave and Noise	120mVp-p
	DC output Power	360W
	Efficiency	85%
	DC Voltage Adjustable Scope	(at full load)≤0.5%
Input	Voltage Range	180~240VAC 47-63Hz
	Input Current	3.4A/115A, 1.7A/230V
	Leakage Current	<1mA/ 240VAC
	Inrush Current	Cold start 20A/120VAC, 40A/230VAC
Protection	Over-load	105%~135%, Protection type: Constant current limiting, recovers automatically after fault condition is removed
	Over-voltage	105%---150% Rated Voltage, Protection type: Shut off
	High-temperature	RTH3>=65°C FAN ON<=55°C FAN OFF>=80°C Cut off output(5~15V)
Environment	Working temperature & humidity	-10°C~+50°C, 20~90%RH
	Store temperature & humidity	-20°C~+85°C, 10~95%RH
	Temperature coefficient	±0.03%/°C(0~50°C)
	Vibration	10~500Hz,2G 10min./1cycle,Period for 60min,EACH AXES
Safety	Withstand voltage	I/P-O/P: 1.5KVAC, I/P-FG: 1.5KVAC, O/P-FG: 0.5KVAC
	Isolation resistance	I/P-O/P,I/P-FG,O/P-FG: 100M Ohms/500VDC
Standard	CE EMC Standard	EN55015:2013+A1:2015, EN61547:2009, EN61000-3-2:2014, EN61000-3-33:2013
	CE LVD Standard	EN61347-2-13:2014+A1:2017, EB61347-1:2015
	ROHS Standard	IEC 62321: 2013, EPA3050B:1996, EN1122:2001, EPA3052:1996, EPA3060A, etc.
Other	Dimension	215*315*63mm (L*W*H)
	Weight	2.1kg
Notes	<ol style="list-style-type: none"> 1. All parameters NOT specially mentioned are measured at 230VAC input, rated load and 25°C of ambient temperature. 2. Ripple & noise are measured at 20MHz of bandwidth by using a 12" twisted pair-wire terminated with a 0.1uf & 47uf parallel capacitor. 3. Tolerance : includes set up tolerance, line regulation and load regulation. 4. I/P-O/P: Input and output interval, I/P-FG: Input and enclosure, O/P-FG: Output and enclosure 	

Centralized Power Supply

SB-480W-12-18



CE FC



Feature:

- 480W 18chs. Output Power Supply Box
- Output voltage & current: DC12V 40A
- Input voltage range: 85~264VAC
- Built in EMI filter with tiny ripple
- 100% full load burn-in test
- Forced air Cooling by built-in DC fan
- Built-in constant current limiting circuit (C.C.+C.V.mode);
- Protection: Short circuit/ Overload/ Over voltage/ Over temperature

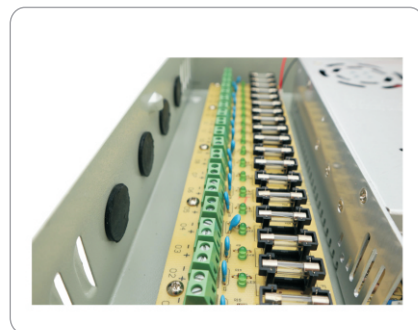
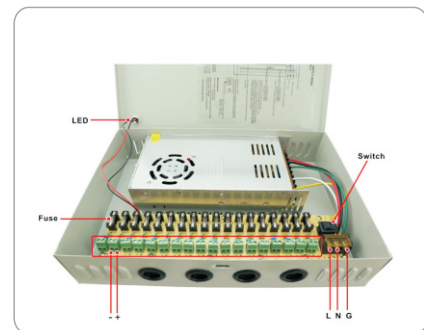

Specification:

Model	SB-480W-12-18	
Output	DC output Voltage	12V±1%
	Output Current Range	0-40A
	Wave and Noise	120mVp-p
	DC output Power	480W
	Efficiency	85%
	DC Voltage Adjustable Scope	(at full load)≤0.5%
Input	Voltage Range	180~240VAC 47-63Hz
	Input Current	4.6A/115A, 3.2A/230V
	Leakage Current	<1mA/ 240VAC
	Inrush Current	Cold start 20A/120VAC, 40A/230VAC
Protection	Over-load	105%~135%, Protection type: Constant current limiting, recovers automatically after fault condition is removed
	Over-voltage	105%---150% Rated Voltage, Protection type: Shut off
	High-temperature	RTH3>=65°C FAN ON<=55°C FAN OFF>=80°C Cut off output(5~15V)
Environment	Working temperature & humidity	-10°C~+50°C, 20~90%RH
	Store temperature & humidity	-20°C~+85°C, 10~95%RH
	Temperature coefficient	±0.03%/°C(0~50°C)
	Vibration	10~500Hz,2G 10min./1cycle,Period for 60min,EACH AXES
Safety	Withstand voltage	I/P-O/P: 1.5KVAC, I/P-FG: 1.5KVAC, O/P-FG: 0.5KVAC
	Isolation resistance	I/P-O/P,I/P-FG,O/P-FG: 100M Ohms/500VDC
Standard	CE EMC Standard	EN55015:2013+A1:2015, EN61547:2009, EN61000-3-2:2014, EN61000-3-33:2013
	CE LVD Standard	EN61347-2-13:2014+A1:2017, EB61347-1:2015
	ROHS Standard	IEC 62321: 2013, EPA3050B:1996, EN1122:2001, EPA3052:1996, EPA3060A, etc.
Other	Dimension	215*315*63mm (L*W*H)
	Weight	2.3kg
Notes	<ol style="list-style-type: none"> 1. All parameters NOT specially mentioned are measured at 230VAC input, rated load and 25°C of ambient temperature. 2. Ripple & noise are measured at 20MHz of bandwidth by using a 12" twisted pair-wire terminated with a 0.1uf & 47uf parallel capacitor. 3. Tolerance : includes set up tolerance, line regulation and load regulation. 4. I/P-O/P: Input and output interval, I/P-FG: Input and enclosure, O/P-FG: Output and enclosure 	